

2021 Annual Drinking Water Quality Report

For
Wareham Fire District - Water Department
Wareham, Massachusetts
MassDEP PWSID # 4310000

This report is a snapshot of drinking water quality that the Wareham Fire District - Water Department (District) provided in the 2021 calendar year. Included are details about where your water comes from, what it contains, and how it compares to state and federal standards. We are committed to providing you with this information because informed customers are our best allies.

I. PUBLIC WATER SYSTEM INFORMATION

Address: **2550 Cranberry Highway, Wareham, MA 02571**

Contact Person: **Andrew Cunningham, Water Superintendent**

Telephone #: **508-295-0450**

Fax #: **508-291-2737**

Internet Address: www.warehamfiredistrict.org

Water System Improvements

Our water system is routinely inspected by the Massachusetts Department of Environmental Protection (MassDEP). MassDEP inspects our system for its technical, financial, and managerial capacity to provide safe drinking water to you. To provide the highest quality of water available, we typically perform over 3,500 water quality tests annually!

In addition, the United States Environmental Protection Agency roughly every 5 years publishes a list of potential contaminants to monitor in our water (Unregulated Contaminant Rule or UCMR). The results of this testing are used to modify the National Primary Drinking Water Regulations. Coupled with the above, your water system is operated by a set of qualified Massachusetts certified operators who oversee the routine operations of our system and are required to obtain a set number of continuing education training hours by the State. In short, the District takes our job seriously about providing safe water.

In FY19 (Calendar year 2019/2020), the Board of Water Commissioners (BoWC) set the following three-five year plan (not in order of importance) otherwise known as Strategic Plan:

1. Painting the Bourne Hill and West Wareham Storage Tanks
2. Continue automating the work order and bill process.
3. Improve the District Financial Rating,
4. Reduce Energy Cost and Lower Carbon-Footprint,
5. Reduce Length of Bill Payment Plans,
6. Increase Safety Culture,
7. Earlier Planning for Each Proceeding Fiscal Year,
8. Regulatory Compliance,
9. Improving Management and Staffing Structure,

10. Improving Public Communication,
11. Reviewing Labor Requirements,
12. Optimizing Chlorine Usage,
13. More Facility Maintenance,
14. Replacement of Meters with Smart Meters (AMR/AMI) using inhouse labor,
15. Replacement of the telephone system District wide.

Below highlights the major achievements from the above goals. The District was able to obtain grant funding for over two thirds of the solar panel cost project through MassDEP. These panels supply upwards of 100,000 KW-hr annually and help to defray to electrical cost for operating the water purification plant and reduce the District's carbon footprint (Picture 1).

Picture 1: 67 KW AC Solar on the roof of the Maple Springs Water Purification Plant



In 2021, the District completed construction of the Maple Springs Water Purification Plant (MSWPP) and was given approval by the MassDEP for its operation. The MSWPP first went online in April 2021. Required by the MassDEP for the first 6 months of operation the plant was only allowed to be operated while fully manned during the workweek. Proposed staffing schedule changes will accommodate operations of the MSWPP seven days per week or as needed to meet the daily flow demands. This MSWPP project is one of the largest endeavors of the District and will improve water quality for years to come by chemically treating and filtering out manganese before water is pumped out to the distribution system. In conjunction with the District's annual Uni-directional hydrant flushing program and increased full time operation of the MSWPP this new combined treatment and best management practice approach will reduce customer discolored water complaints related to manganese, The MSWPP also maintains better control over the chlorine that is used for disinfection in the system as a whole.

In 2021 with a warrant article approving funding by the district voters. With assistance by a contracted professional engineering firm efforts began on the application process for a reimbursable grant to purchase and install emergency power equipment for both the new MSWPP and all the associated Maple Springs Wells 1, 2, 3, 4, and 9. Completion of the grant application and potential award is anticipated in sometime in 2022.

Also in 2021, the District entered into an agreement with a professional engineering firm to develop bid specifications for advertising a request for quotations to move forward on the painting and surface recoating of the two large storage tanks, Bourne Hill and West Wareham. It is anticipated that requests for quotes will be completed early in 2022, bids reviewed and funding requested to award be authorized at 2022 annual district meeting.

Opportunities for Public Participation

If you would like to participate in discussions regarding your water quality, you may attend the Board of Water Commissioner meeting which typically occurs on the first and third Monday night of the month at 5:30 pm at the Water Department office (check posting on District website, Town Hall, Town online calendar, and the Water Department office for official dates and times).

Educational events also can be found via the local water works association website or other websites as follows:

- *New England Water Works Association* (<http://www.newwa.org/>)
- *American Water Works Association* (<http://www.awwa.org/>)
- *Massachusetts Water Works Association* (<https://mwwa.memberclicks.net/>)
- *Massachusetts Department of Environmental Protection* (<http://www.mass.gov/eea/agencies/massdep/>)
- *Plymouth County Water Works Association* (<http://www.pcwwa.org/>)
- *United States Geological Survey* (<http://www.usgs.gov/water/>)
- *Buzzards Bay Coalition* (<http://www.savebuzzardsbay.org/>)
- *United States Environmental Protection Agency Office of Water* (<https://www.epa.gov/aboutepa/about-office-water>)

Picture 2: Maple Springs Water Purification Plant Filtration and Disinfection System



2. YOUR DRINKING WATER SOURCE

Where Does My Drinking Water Come From?

The District's water originates from seven active gravel packed wells (soon to be eight) within the Plymouth-Carver sole source aquifer, the second largest aquifer in the State of Massachusetts. A list of wells and common well names are provided in the Table 1b below. Each well is drilled to a depth ranging from 55 to 100 feet. The wells are located in isolated areas of Maple Springs and Seawood Springs. The District works hard to protect these wells from potential contamination. You can be assured that the Board of Water Commissioners considers protection of both well fields as their top priority. District owned land now adds up to 350 acres permanently protected. The District pumps just about 500 million gallons annually.

Table 1: List of Well Sources that Supply Water to the District

Source Name	MassDEP Source ID#	Source Type	Location of Source
Well #1	4310000-01G	Groundwater	Maple Spring Wellfield
Well #2	4310000-02G	Groundwater	Maple Spring Wellfield
Well #3	4310000-03G	Groundwater	Maple Spring Wellfield
Well #4	4310000-04G	Groundwater	Maple Spring Wellfield
Well #6	4310000-06G	Groundwater	Seawood Spring Wellfield

Well #7	4310000-07G	Groundwater	Seawood Spring Wellfield
Well #8	4310000-08G	Groundwater	Seawood Spring Wellfield (Southline Well)
Well #9	4310000-09G	Groundwater	Maple Park Well (Pending Activation)

Is My Water Treated?

Our water system makes every effort to provide you with safe and pure drinking water. To improve the quality of the water delivered to you, we treat it to address several contaminants.

- We add a disinfectant to protect you against microbial contaminants.
 - All ground water sources contain numerous microorganisms some of which can cause people to be sick. To eliminate disease carrying organisms it is necessary to disinfect the water.
 - Disinfection does not sterilize the water, but it does destroy harmful organisms. Sterilization kills all microorganisms, even though most are not harmful, and is too costly to use on a routine basis for drinking water. The District uses sodium hypochlorite (i.e. chlorine) as its primary disinfectant. Chlorine destroys organisms by penetrating cell walls and reacting with enzymes. Disinfection with chlorine has been proven to be effective against harmful organisms and making the water safe to drink.
- We chemically treat the water with lime to reduce lead and copper concentrations (i.e. limit pipe and asset corrosion).
 - Many drinking water sources in New England are naturally corrosive (i.e., they have a pH that is less than 7.0). The District is no exception to this phenomenon. So, the natural water supplied tends to corrode and dissolve the metal piping it flows through. This not only damages pipes but can also add metals, such as lead and copper, to the water which can be harmful in elevated concentrations. For this reason, it is beneficial to add a chemical that makes the water alkaline.
 - To raise the raw water pH, the District adds a natural agent, hydrated lime (calcium hydroxide) to its water. The lime is typically mined in the United States and Canada and then refined for using in drinking water applications. Adding lime adjusts the water to a non-corrosive pH value. Testing throughout the water system has shown that this treatment has been effective at reducing lead and copper concentrations.
- We sequester iron and manganese. Iron and manganese are often present in groundwater at levels that can discolor the water or cause it to take on unpleasant odors or tastes. Even though the water may still be safe to drink, treatment is often desirable.
 - Adding polyphosphates results in a chemical reaction, known as sequestration, which slows the formation of iron and manganese nuisance particles out in the distribution system which then discolors the water, typically brown in color. Sequestering at Well No. 3 was discontinued in mid to late 2020 once the Water Purification Plant was built. The polyphosphate system will be transitioned to Well No. 6 once approved by MassDEP.
- All chemicals used by the District are approved for water treatment by one or more of the following organizations: National Sanitation Foundation (Now known as NSF International), or UL, both accredited by the American National Standards Institute (ANSI). Chemicals also must meet performance standards established by the American Water Works Association (AWWA).

The water quality of our system is constantly monitored by the District and MassDEP to determine the effectiveness of the existing water treatment and to determine if any additional treatment is required. Prior water quality test results show that the water needs to be treated to continue to meet these goals.

How Are These Sources Protected?

MassDEP has prepared a Source Water Assessment Program (SWAP) Report for the water supply source(s) serving this water system. The SWAP Report assesses the susceptibility of public water supplies to contaminants. It can be obtained from the DEP website:

<http://www.mass.gov/eea/docs/dep/water/drinking/swap/sero/4310000.pdf> .

What Are the Key Issues for Our Water Supply?

The SWAP Report notes the highest potential source of contamination threat comes from improper pesticide storage or use and illegal clandestine dumping of trash that may contain hazardous materials or waste. The SWAP Report commends the Wareham Fire District for taking an active role in promoting source protection measures in the Water Supply Protection Areas through:

- The acquisition of undeveloped lands within the Zone II recharge area
- Supporting residential growth management within the Zone II and
- Conducting an independent study of pesticide and herbicide impacts on the groundwater in the Zone II.

What is My System's Ranking?

A susceptibility ranking of *high* was assigned to this system using the information collected during the assessment by MassDEP due to the agricultural work as well as potential clandestine dumping combined with the relatively high rate of groundwater movement in the area.

What Can Be Done to Improve Protection?

The SWAP report recommends the District continue following best management practices as outlined in the report. In addition to this the District is taking active steps to address the protection recommendations by the design and ultimate construction of the new water purification plant.

Residents can help protect sources by:

- Practicing good septic system maintenance.
- Supporting water supply protection initiatives at the Town and District annual meetings.
- Taking hazardous household chemicals to hazardous materials collection days.
- Limiting pesticide and fertilizer use, etc.
- Reporting any suspicious activities to Water Department and/or Wareham Police.

3. SUBSTANCES FOUND IN TAP WATER

Generally speaking, sources of drinking water (both tap water and bottled water) include rivers, lakes, streams, ponds, reservoirs, springs, and wells. As water travels over the surface of the land or through the ground, it dissolves naturally occurring minerals, and in some cases, natural radioactive material, and can pick up substances resulting from the presence of animals or from human activity.

Contaminants that may be present in source water include:

Microbial contaminants -such as viruses and bacteria, which may come from sewage treatment plants, septic systems, agricultural livestock operations, and wildlife.

Inorganic contaminants -such as salts and metals, which can be naturally occurring or result from urban stormwater runoff, industrial, or domestic wastewater discharges, oil and gas production, mining, and farming.

Pesticides and herbicides -which may come from a variety of sources such as agriculture, urban stormwater runoff, and residential uses.

Organic chemical contaminants -including synthetic and volatile organic chemicals, which are by-products of industrial processes and petroleum production, and can also come from gas stations, urban stormwater runoff, and septic systems.

Radioactive contaminants -which can be naturally occurring or be the result of oil and gas production and mining activities.

In order to ensure that tap water is safe to drink, the Department of Environmental Protection (MassDEP) and U.S. Environmental Protection Agency (EPA) prescribe regulations that limit the amount of certain contaminants in water provided by public water systems. The Food and Drug Administration (FDA) and Massachusetts Department of Public Health (DPH) regulations establish limits for contaminants in bottled water that must provide the same protection for public health. **All drinking water, including bottled water, may reasonably be expected to contain at least small amounts of some contaminants. The presence of contaminants does not necessarily indicate that water poses a health risk. More information about contaminants and potential health effects can be obtained by calling the EPA's Safe Drinking Water Hotline (800-426-4791).**

Some people may be more vulnerable to contaminants in drinking water than the general population. Immuno-compromised persons such as persons with cancer undergoing chemotherapy, persons who have undergone organ transplants, people with HIV/AIDS or other immune system disorders, some elderly, and some infants can be particularly at risk from infections. These people should seek advice about drinking water from their health care providers. EPA/Centers for Disease Control and Prevention (CDC) guidelines on lowering the risk of infection by microbial contaminants are available from the Safe Drinking Water Hotline (800-426-4791).

If present, elevated levels of lead can cause serious health problems, especially for pregnant women and young children. Lead in drinking water is primarily from materials and components associated with service lines and home plumbing. The District is responsible for providing high quality drinking water but cannot control the variety of materials used in home plumbing components. When your water has been sitting for several hours, **you can minimize the potential for lead exposure by flushing your tap for 30 seconds to 2 minutes before using water for drinking or cooking.** If you are concerned about lead in your water, you may wish to have your water tested. Information on lead in drinking water, testing methods, and steps you can take to minimize exposure is available from the Safe Drinking Water Hotline or at: <http://www.epa.gov/lead/protect-your-family#water>.

4. IMPORTANT DEFINITIONS

Action Level (AL) – The concentration of a contaminant which, if exceeded, triggers treatment or other requirements that a water system must follow.

Level 1 Assessment - A Level 1 assessment is a study of the water system to identify potential problems and determine (if possible) why total coliform bacteria have been found in our water system.

Level 2 Assessment - A Level 2 assessment is a very detailed study of the water system to identify potential problems and determine (if possible) why an E. Coli MCL violation has occurred and/or why total coliform bacteria have been found in our water system on multiple occasions.

Massachusetts Office of Research and Standards Guideline (ORSG) – This is the concentration of a chemical in drinking water, at or below which, adverse health effects are unlikely to occur after chronic (lifetime) exposure. If exceeded, it serves as an indicator of the *potential* need for further action. These are not regulated contaminants.

Maximum Contaminant Level (MCL) – The highest level of a contaminant that is allowed in drinking water. MCLs are set as close to the MCLGs as feasible using the best available treatment technology.

Maximum Contaminant Level Goal (MCLG) – The level of a contaminant in drinking water below which there is no known or expected risk to health. MCLGs allow for a margin of safety.

Maximum Residual Disinfectant Level (MRDL) – The highest level of a disinfectant (chlorine, chloramines, chlorine dioxide) allowed in drinking water. There is convincing evidence that addition of a disinfectant is necessary for control of microbial contaminants.

Maximum Residual Disinfectant Level Goal (MRDLG) – The level of a drinking water disinfectant (chlorine, chloramines, chlorine dioxide) below which there is no known or expected risk to health. MRDLG's do not reflect the benefits of the use of disinfectants to control microbial contaminants.

Secondary Maximum Contaminant Level (SMCL) – These standards are developed to protect the aesthetic qualities of drinking water and are not health based.

Treatment Technique (TT) – A required process intended to reduce the level of a contaminant in drinking water.

Variations and Exemptions – State or EPA permission not to meet an MCL or a treatment technique under certain conditions.

90th Percentile – Out of every 10 homes sampled, 9 samples were at or below this level.

A Word About Concentrations and Their Abbreviations (adopted from Cornell University)

Source: <http://pmep.cce.cornell.edu/profiles/extoxnet/TIB/ppm.html>

Parts per million (ppm or mg/L), parts per billion (ppb or µg/L), and parts per trillion (ppt or ng/L), are the most commonly used terms to describe very small amounts of contaminants in our environment. But what do these terms represent? They are measures of concentration, the amount of one material in a larger amount of another material. They are expressed as concentrations rather than total mass so we can easily compare a variety of different environmental situations. For example, scientists can measure the concentration of a chemical in the Great Lakes by looking at small samples. They do not have to measure the total amount of chemicals or water in all of the lakes, which would be feat indeed if they did!

An example might help illustrate the part per ... idea. If you divide a pie equally into 10 pieces, then each piece would be a part per ten; for example, one-tenth of the total pie. If, instead, you cut this pie into a million pieces, then each piece would be very small and would represent a millionth of the total pie or one part per million of the original pie. If you cut each of these million minute ("my-NOOT") pieces into a thousand little pieces, then each of these new pieces would be one part per billion of the original pie. To give you an idea of how little this would be, a pinch of salt in ten tons of potato chips is also one part (salt) per billion parts (chips).

In the above example, the pieces of the pie were made up of the same material as the whole. However, if there was a contaminant in the pie at a level of one part per billion, one of these invisible pieces of pie would be made up of the contaminant and the other 999,999,999 pieces would be pure pie. Similarly, one part per billion of an impurity in water represents a tiny fraction of the total amount of water. One part per billion is the equivalent of one drop of impurity in 500 barrels of water.

ppm = parts per million, or milligrams per liter (mg/L)
ppb = parts per billion, or micrograms per liter (µg/L)
ppt = parts per trillion, or nanograms per liter (ng/L)
pCi/l = picocuries per liter (a measure of radioactivity)
NTU = Nephelometric Turbidity Units

ND = Not Detected
 N/A = Not Applicable
 mrem/year = millirem per year (a measure of radiation absorbed by the body)

Picture 3: Sampling at Consumer Tap



5. WATER QUALITY TESTING RESULTS

What Does This Data Represent?

The water quality information presented in the following tables is from the most recent round of testing done in accordance with the regulations. All data shown was collected during the last calendar year unless otherwise noted in the tables.

Starting for the year 2016, MassDEP has reduced the monitoring requirements for disinfection byproducts in the District distribution system because the source is not at risk of high formation levels when chlorine is implemented. The last sample set collected for these contaminants was taken in November 2021 and were found to meet all applicable US EPA and MassDEP standards. The District will continue to monitor disinfection byproducts annually (Table 5).

With the startup of the new Maple Springs Water Purification Plant in 2021 the District was required to go back on a semiannual lead and copper sample schedule. After three rounds of full compliance with the lead and copper rule the District will be able to request to return to a reduced sample schedule in the future. The District treats to raise the pH of the water to approximately 9.0 to provide optimal corrosion control and maintain low levels of lead and copper in the tap water. The last round of sampling was in 2021 and was found to meet all applicable US EPA and MassDEP standards (Table 2). The next two rounds of lead and copper sampling is scheduled for 2022.

Table 2: Lead and Copper (Distribution System – Lead and Copper Rule)

	Date(s) Collected	90 TH percentile	Action Level	MCLG	# of sites sampled	# of sites above Action Level	Possible Source of Contamination
Lead (ppb)	4th. Quarter 2021	2	15	0	60	0	Corrosion of household plumbing systems; Erosion of natural deposits

Copper (ppb)	4th. Quarter 2021	ND	1,300	1,300	60	0	Corrosion of household plumbing systems; Erosion of natural deposits; Leaching from wood preservatives
--------------	-------------------	----	-------	-------	----	---	--

Table 3: Microbiological Contaminants (Distribution System – Total Coliform Rule)

	Highest # Positive Detects in a month	MCL/TT ¹	MCLG	Violation (Y/N)	Possible Source of Contamination
Total Coliform	1 (July – Barlow Ave, All Repeat Samples were Negative)	N/A	N/A	N	Naturally present in the environment
Fecal Coliform or <i>E.coli</i>	NONE	1 ¹	0	N	Human and animal fecal waste

1. Compliance with the Fecal Coliform/*E. Coli* MCL is determined upon additional repeat testing. The MCL is 1 detection.

Table 4: Microbiological Contaminants (Raw water – Groundwater Rule)

	Highest # Positive in a month	MCL/TT ¹	MCLG	Violation (Y/N)	Possible Source of Contamination
Total Coliform	NONE	N/A	N/A	N	Naturally present in the environment and also present in human and animal fecal waste.
Fecal Coliform or <i>E.coli</i>	NONE	1 ¹	0	N	Human and animal fecal waste

1. Compliance with the Fecal Coliform/*E. Coli* MCL is determined upon additional repeat testing. The MCL is 1 detection.

Table 5: Regulated Contaminants

Regulated Contaminant	Date(s) Collected	Highest Result or Running Average Detected	Range Detected	MCL or MRDL	MCLG or MRDLG	Violation (Y/N)	Possible Source(s) of Contamination
Inorganic Contaminants							
Antimony (ppb)	1/4/21	ND	NA	6	6	N	Discharge from fire retardants; ceramics; electronics; solder
Arsenic (ppb)	1/4/21	ND	NA	10	---	N	Erosion of natural deposits; runoff from orchards; runoff from glass and electronics production wastes
Asbestos (MFL)	4/2/13	ND	NA	7	7	N	Decay of asbestos cement water mains; erosion of natural deposits
Barium (ppm)	1/4/21	ND	NA	2	2	N	Discharge of drilling wastes; discharge from metal refineries; erosion of natural deposits
Beryllium (ppb)	1/4/21	ND	NA	4	4	N	Discharge from electrical, aerospace, and defense industries; erosion of natural deposits

Regulated Contaminant	Date(s) Collected	Highest Result or Running Average Detected	Range Detected	MCL or MRDL	MCLG or MRDLG	Violation (Y/N)	Possible Source(s) of Contamination
Cadmium (ppb)	1/4/21	ND	NA	5	5	N	Corrosion of galvanized pipes; erosion of natural deposits; discharge from metal refineries; runoff from waste batteries and paints
Chromium (ppb)	1/4/21	ND	NA	100	100	N	Discharge from pulp mills; erosion of natural deposits
Cyanide (ppb)	1/3/18	ND	NA	200	200	N	Discharge from metal factories; discharge from plastic and fertilizer factories
Fluoride (ppm)*	1/4/21	0.19	NA	4	4	N	Erosion of natural deposits; water additive which promotes strong teeth; discharge from fertilizer and aluminum factories
Mercury (ppb)	1/4/21	ND	NA	2	2	N	Erosion of natural deposits; discharge from refineries and factories; runoff from landfills; runoff from cropland
Nickel (ppm)	1/4/21	ND	NA	0.1	0.1	N	Discharge from industrial processes
Nitrate (ppb)	1/4/21	390	ND-390	10,000	10,000	N	Runoff from fertilizer use; leaching from septic tanks; sewage; erosion of natural deposits
Nitrite (ppm)	1/17/17	ND	NA	1	1	N	Runoff from fertilizer use; leaching from septic tanks; sewage; erosion of natural deposits
Perchlorate (ppb)	7/12/21	0.13	NA	2	N/A	N	Rocket propellants, fireworks, munitions, flares, blasting agents
Selenium (ppb)	1/4/21	ND	NA	50	50	N	Discharge from metal refineries; erosion of natural deposits; discharge from mines
Thallium (ppb)	1/4/21	ND	NA	2	0.5	N	Leaching from ore-processing sites; discharge from electronics, glass, and drug factories
Volatile Organic Contaminants							
Acetone (ppb)	10/18/21	22.9	NA	6,300	-	N	Discharge from municipal or industrial landfills or atmospheric deposition
Benzene (ppb)	10/18/21	ND	NA	5	0	N	Discharge from factories; leaching from gas storage tanks and landfills

Regulated Contaminant	Date(s) Collected	Highest Result or Running Average Detected	Range Detected	MCL or MRDL	MCLG or MRDLG	Violation (Y/N)	Possible Source(s) of Contamination
Carbon tetrachloride (ppb)	10/18/21	ND	NA	5	0	N	Discharge from chemical plants and other industrial activities
Chlorobenzene (ppb)	10/18/21	ND	NA	100	100	N	Discharge from and agricultural chemical factories
o-Dichlorobenzene (ppb)	10/18/21	ND	NA	600	600	N	Discharge from industrial chemical factories
p-Dichlorobenzene (ppb)	10/18/21	ND	NA	5	5	N	Discharge from industrial chemical factories
1,2-Dichloroethane (ppb)	10/18/21	ND	NA	5	0	N	Discharge from industrial chemical factories
1,1-Dichloroethylene (ppb)	10/18/21	ND	NA	7	7	N	Discharge from industrial chemical factories
cis-1,2-Dichloroethylene (ppb)	10/18/21	ND	NA	70	70	N	Breakdown product of trichloroethylene and tetrachloroethylene
trans-1,2-Dichloroethylene (ppb)	10/18/21	ND	NA	100	100	N	Discharge from industrial chemical factories
Dichloromethane (ppb)	10/18/21	ND	NA	5	0	N	Discharge from pharmaceutical and chemical factories
1,2-Dichloropropane (ppb)	10/18/21	ND	NA	5	0	N	Discharge from industrial chemical factories
Ethylbenzene (ppb)	10/18/21	ND	NA	700	700	N	Leaks and spills from gasoline and petroleum storage tanks
MTBE - Methyl Tertiary Butyl Ether (ppb)	10/18/21	ND	NA	--	70	N	Fuel additive; leaks and spills from gasoline storage tanks
Styrene (ppb)	10/18/21	ND	NA	100	100	N	Discharge from rubber and plastic factories; leaching from landfills
Tetrachloroethylene (PCE) (ppb)	10/18/21	ND	NA	5	0	N	Discharge from factories and dry cleaners; residual of vinyl-lined water mains
1,2,4-Trichlorobenzene (ppb)	10/18/21	ND	NA	70	70	N	Discharge from textile-finishing factories
1,1,1-Trichloroethane (ppb)	10/18/21	ND	NA	200	200	N	Discharge from use in septic system cleaners
1,1,2-Trichloroethane (ppb)	10/18/21	ND	NA	5	3	N	Discharge from industrial chemical factories
Trichloroethylene (TCE) (ppb)	10/18/21	ND	NA	5	0	N	Discharge from metal degreasing sites and other factories
Toluene (ppm)	10/18/21	ND	NA	1	1	N	Leaks and spills from gasoline and petroleum storage tanks; discharge from petroleum factories

Regulated Contaminant	Date(s) Collected	Highest Result or Running Average Detected	Range Detected	MCL or MRDL	MCLG or MRDLG	Violation (Y/N)	Possible Source(s) of Contamination
Vinyl Chloride (ppb)	10/18/21	ND	NA	2	0	N	Leaching from PVC piping; discharge from plastics factories
Xylenes (ppm)	10/18/21	ND	NA	10	10	N	Leaks and spills from gasoline and petroleum storage tanks; discharge from petroleum factories; discharge from chemical factories
Synthetic Organic Contaminants							
2,4-D (ppb)	4/20/21	ND	NA	70	70	N	Runoff from herbicide used on row crops
2,4,5-TP (Silvex) (ppb)	4/20/21	ND	NA	50	50	N	Residue of banned herbicide
Acrylamide	4/20/21	ND	NA	TT=5%	0	N	Added to water during sewage/wastewater treatment
Alachlor (ppb)	4/20/21	ND	NA	2	0	N	Runoff from herbicide used on row crops
Atrazine (ppb)	4/20/21	ND	NA	3	3	N	Runoff from herbicide used on row crops
Benzo(a)pyrene (ppt)	4/20/21	ND	NA	200	0	N	Leaching from linings of water storage tanks and distribution lines
Carbofuran (ppb)	4/20/21	ND	NA	40	40	N	Leaching of soil fumigant used on rice and alfalfa
Chlordane (ppb)	4/20/21	ND	NA	2	0	N	Residue of banned termiticide
Dalapon (ppb)	4/20/21	ND	NA	200	200	N	Runoff from herbicide used on rights of way
Di (2-ethylhexyl) adipate (ppb)	4/20/21	ND	NA	400	400	N	Discharge from chemical factories
Di (2-ethylhexyl) phthalate (ppb)	4/20/21	ND	NA	6	0	N	Discharge from rubber and chemical factories
Dibromochloropropane (DBCP) (ppt)	4/20/21	ND	NA	200	0	N	Runoff/leaching from soil fumigant used on soybeans, cotton, and orchards
Dinoseb (ppb)	4/20/21	ND	NA	7	7	N	Runoff from herbicide used on soybeans and vegetables
Endrin (ppb)	4/20/21	ND	NA	2	2	N	Residue of banned insecticide
Epichlorohydrin	4/20/21	ND	NA	TT=1%	0	N	Discharge from industrial chemical factories; an impurity of some water treatment chemicals
Ethylene dibromide (EDB) (ppt)	4/20/21	ND	NA	20	0	N	Residue of leaded gasoline or runoff from soil fumigant used on tobacco or strawberries
Heptachlor (ppt)	4/20/21	ND	NA	400	0	N	Residue of banned pesticide
Heptachlor epoxide (ppt)	4/20/21	ND	NA	200	0	N	Breakdown of heptachlor

Regulated Contaminant	Date(s) Collected	Highest Result or Running Average Detected	Range Detected	MCL or MRDL	MCLG or MRDLG	Violation (Y/N)	Possible Source(s) of Contamination
Hexachlorobenzene (ppb)	4/20/21	ND	NA	1	0	N	Discharge from metal refineries and agricultural chemical factories
Hexachlorocyclopentadiene (ppb)	4/20/21	ND	NA	50	50	N	Discharge from chemical factories
Lindane (ppt)	4/20/21	ND	NA	200	200	N	Runoff/leaching from insecticide used on cattle, lumber, gardens
Methoxychlor (ppb)	4/20/21	ND	NA	40	40	N	Runoff/leaching from insecticide used on fruits, vegetables, alfalfa, livestock
Oxamyl (Vydate) (ppb)	4/20/21	ND	NA	200	200	N	Runoff/leaching from insecticide used on apples, potatoes and tomatoes
Polychlorinated biphenyls (PCBs) (ppt)	4/20/21	ND	NA	500	0	N	Runoff from landfills; discharge of waste chemicals; residue of banned use in electrical transformers
Pentachlorophenol (ppb)	4/20/21	ND	NA	1	0	N	Discharge from wood preserving factories
Picloram (ppb)	4/20/21	ND	NA	500	500	N	Herbicide runoff
Simazine (ppb)	4/20/21	ND	NA	4	4	N	Herbicide runoff
Toxaphene (ppb)	4/20/21	ND	NA	3	0	N	Runoff/leaching from insecticide used on cotton and cattle

Blank Row – go to next page

Disinfectants and Disinfection By-Products

Regulated Contaminant	Date(s) Collected	Highest Result Detected	Range Detected	MCL or MRDL	MCLG or MRDLG	Violation (Y/N)	Possible Source(s) of Contamination
Total Trihalomethanes (TTHMs) (ppb)	4 th Quarter 2021	11.9	1.4 – 11.9	80	-----	N	Byproduct of drinking water disinfection
Haloacetic Acids (HAA5) (ppb)	4 th Quarter 2021	2.0	ND – 2.0	60	-----	N	Byproduct of drinking water disinfection
Chlorine (ppm) (free)	Monthly in 2021	Average = 0.35	0.33 – 0.37	4	4	N	Disinfectant used to control microbes

*Fluoride also has a secondary contaminant level (SMCL) of 2 ppm.

Unregulated contaminants are those for which there are no established drinking water standards. The purpose of unregulated contaminant monitoring is to assist regulatory agencies in determining their occurrence in drinking water and whether future regulation is warranted. Secondary contaminants are contaminants that can cause aesthetic issues that may cause a person to obtain water from another, perhaps less safe, water source. Guidelines, when provided by ORSG, are listed in the tables.

Table 6: Secondary and Unregulated Contaminants

Unregulated and Secondary Contaminants	Date(s) Collected	Result or Range Detected	Average Detected	SMCL	ORSG	Possible Source
Inorganic Contaminants						
Sodium (ppm)	1/4/21	9.3	NA	----	20	Natural sources; runoff from use as salt on roadways; by-product of treatment process
Nickel (ppm)	1/4/21	ND	---	----	0.1	Discharge from industrial processes
Other Organic Contaminants						
Synthetic Organic Compound Detected in Monitoring Wells and/or Production Wells						
2,6-Dichlorobenzamide Trade name -BAM (ppb)	2020	0.3 - 1.5	---	---	30/110	Breakdown product of agricultural chemical, typically from Casoron. MassDEP established an Interim Drinking Water Guideline for BAM of 30 ug/L for children and 110 ug/L for adults.
Propyzamide (ppb)	2020	ND	---	---	---	Agricultural Chemical
Diazinon (ppb)	2020	ND	---	---	---	Agricultural Chemical
Chlorpyrifos (ppb)	2020	ND	---	---	---	Agricultural Chemical
Prothioconazole (ppb)	2020	Nd	---	---	---	Agricultural Chemical
Mesotrione (ppb)	2020	ND	---	---	---	Agricultural Chemical
Pentachlorophenol (ppb)	2020	ND	---	---	---	Agricultural Chemical
Imazapyr (ppb)	2020	ND	---	---	---	Agricultural Chemical
Bromacil (ppb)	2020	ND	---	---	---	Agricultural Chemical
Azoxystrobin, (ppb)	2020	ND-0.073	---	---	1,260	Agricultural Chemical. ORSG value estimated from EPA Office of Pesticide Programs Reference Dose
Chlorantranilprole, (ppb)	2020	ND-1.23	---	---	11,060	Agricultural Chemical. ORSG value estimated from EPA Office of Pesticide Programs Reference Dose
Clothianidin, (ppb)	2020	ND-0.40	---	---	68.6	Agricultural Chemical. ORSG value estimated from EPA Office of Pesticide Programs Reference Dose
Difenoconazole, (ppb)	2020	ND-0.05	---	---	67.2	Agricultural Chemical. ORSG value estimated from EPA Office of Pesticide Programs Reference Dose
Indoxacarb Trade name: Avaunt; Steward (ppb)	2020	ND-0.015	---	---	140	Agricultural Chemical
Metsulfuron methyl, (ppb)	2020	ND-0.02	---	---	1,750	Agricultural Chemical. ORSG value estimated from EPA Office of Pesticide Programs Reference Dose
Fenbuconazole, (ppb)	2020	0.01-0.09	---	---	97.5	Agricultural Chemical. ORSG value estimated from EPA Office of Pesticide Programs Reference Dose
Spinetoram (ppb)	2020	ND-0.013	---	---	174.3	Agricultural Chemical. ORSG value estimated from EPA Office of Pesticide Programs Reference Dose

Unregulated and Secondary Contaminants	Date(s) Collected	Result or Range Detected	Average Detected	SMCL	ORSG	Possible Source
Carbaryl Trade name: Sevin (ppb)	2020	ND	---	---	40	Agricultural Chemical
Chlorothalonil Trade name: Bravo (ppb)	2020	ND	---	---	1.5	Agricultural Chemical
Dichlobenil Trade name: Casoron (ppb)	2020	ND	---	---	7	Agricultural Chemical
Methoxyfenozide Trade name: Intrepid (ppb)	2020	0.004-0.01	---	---	700	Agricultural Chemical
Napropamide Trade name: Devrinol (ppb)	2020	0.02-0.03	---	---	700	Agricultural Chemical. ORSG value estimated from EPA Office of Pesticide Programs Reference Dose
Norflurazon Trade name: Evital (ppb)	2020	0.01-0.07	---	---	10	Agricultural Chemical
Secondary Contaminants						
Iron (ppb)	9/7/21	ND	ND	300	---	Naturally occurring, corrosion of cast iron pipes
Manganese ¹ (ppb)	9/7/21	ND - 65	37.5	50	Health Advisory: 300	Erosion of natural deposits
Sulfate (ppm)	9/7/21	4.3 – 4.6	4.45	250	----	Natural sources
Aluminum (ppb)	9/7/21	20 - 30	25	200	---	Byproduct of treatment process
Chloride (ppm)	9/7/21	11.3 – 12.5	11.9	250	---	Runoff from road de-icing, use of inorganic fertilizers, landfill leachates, septic tank effluents, animal feeds, industrial effluents, irrigation drainage, and seawater intrusion in coastal areas
Color (C.U.)	9/7/21	ND	ND	15	---	Naturally occurring organic material
Copper (ppm)	9/7/21	ND	ND	1	---	Naturally occurring organic material
Odor (T.O.N.)	9/7/21	4 - 8	6	3 TON	---	Erosion of natural deposits; Leaching from wood preservatives ⁰
pH Bourne Hill Tank	2021 Daily Average	---	9.4	6.5-8.5 ²	---	-----
pH Glen Charlie Tank	2021 Daily Average	---	9.4	6.5-8.5 ²	---	-----
pH West Wareham Tank	2021 Daily Average	---	9.4	6.5-8.5 ²	---	-----
Silver (ppm)	9/7/21	ND	ND	0.1	---	Erosion of natural deposits
Total Dissolved Solids (TDS) (ppm)	9/7/21	68 - 87	72.5	500	---	Erosion of natural deposits.
Turbidity (NTU)	9/7/21	2.2	2.0 - 2.4	5	--	Soil runoff, iron and manganese particles
Zinc (ppm)	9/7/21	ND	ND	5	---	Erosion of natural deposits, leaching from plumbing materials

1. Drinking water may naturally have manganese and, when concentrations are greater than 50 µg/L, the water may be discolored and taste bad. Over a lifetime, the US EPA recommends that people limit their consumption of water with levels over 1,000 µg/L (1 mg/L), primarily due to concerns about the possible neurological effects. Children up to one year of age should not be given water with manganese concentrations over 300 µg/L (0.30 mg/L), nor should formula for infants be made with that water for longer than 10 days.

2. This range of values is set to avoid adverse aesthetic impacts. Alternate system-specific values for pH may be generated for other program areas (e.g., Lead and Copper Rule water quality parameters; Immediate Action Level for Water Treatment Plant Chemicals). In the District's case, the District targets a pH of 9.2 to 9.5 for meeting the Lead and Copper Rule.

Table 7: Per- and Polyfluoroalkyl Substances (PFAS)

Location	Date Sampled	Result	MCL	
Maple Springs Plant – PFAS (ng/L)	April, July and October 2021	All Non-Detects	20	Byproduct of consumer, commercial, and industrial products
Seawood Springs Plant – PFAS (ng/L)	April, July and October 2021	All Non-Detects	20	Byproduct of consumer, commercial, and industrial products

6. COMPLIANCE WITH DRINKING WATER REGULATIONS

Does My Drinking Water Meet Current Health Standards?

We are committed to providing you with the best water quality available. *We are required to monitor your drinking water for specific contaminants on a regular basis. Results of regular monitoring are an indicator of whether or not your drinking water meets health standards. In 2020 we had no violations.*

Other Health Effects Statements

Inadequately treated water may contain disease-causing organisms. These organisms include bacteria, viruses, and parasites, which can cause symptoms such as nausea, cramps, diarrhea, and associated headaches.

- Coliforms are bacteria that are naturally present in the environment and are used as a potential indicator that other, potentially harmful, waterborne pathogens may be present or that a potential pathway exists through which contamination may enter the drinking water distribution system. We detected total coliform on two separate occasions and testing on the same sample set indicated no E. Coli was present. The required follow-up sample set in November 2019 was not taken in error which placed the District in violation of the Revised Total Coliform Rule.
- Fecal coliforms and *E.coli* are bacteria whose presence indicates that the water may be contaminated with human or animal wastes. Microbes in these wastes can cause short-term effects, such as diarrhea, cramps, nausea, headaches, or other symptoms. They may pose a special health risk for infants, young children, and people with severely-compromised immune systems. No fecal coliforms or *E. Coli* were found in the samples taken in 2019.

7. EDUCATIONAL INFORMATION

Do I Need To Be Concerned About Certain Contaminants Detected In My Water?

The District makes great efforts to provide its customers safe drinking water. Below is some guidance language regarding contaminants found in our drinking water that is required to be provided as part of our consumer confidence report.

Lead: If present, elevated levels of lead can cause serious health problems, especially for pregnant women and young children. Lead in drinking water is primarily from materials and components associated with service lines and home plumbing. The District is responsible for providing high quality drinking water but cannot control the variety of materials used in home plumbing components. When your water has been sitting for several hours, you can minimize the potential for lead exposure by flushing your tap for 30 seconds to 2 minutes before using water for drinking or cooking. If you are concerned about lead in your water, you may wish to have your water tested. Information on lead in drinking water, testing methods, and steps you can take to minimize exposure is available from the Safe Drinking Water Hotline or at <http://www.epa.gov/lead/protect-your-family#water>.

Manganese: Manganese is a naturally occurring mineral found in rocks, soil and groundwater, and surface water. Manganese is necessary for proper nutrition and is part of a healthy diet, but can have undesirable effects on certain sensitive populations at elevated concentrations. The United States Environmental Protection Agency (EPA) and MassDEP have set an aesthetics-based Secondary Maximum Contaminant Level (SMCL) for manganese of 50 µg/L (micrograms per liter), or 50 parts per billion. Drinking water may naturally have manganese and, when concentrations are greater than 50 µg/L, the water may be discolored and taste bad. In addition, EPA and MassDEP have also established public health advisory levels. Over a lifetime, EPA recommends that people drink water with manganese levels less than 300 µg/L and over the short term, EPA recommends that people limit their consumption of water with levels over 1,000 µg/L, primarily due to concerns about possible neurological effects. Children up to 1 year of age should not be given water with manganese concentrations over 300 µg/L, nor should formula for infants be made with that water for longer than 10 days. For more information, see the following link: <http://www.epa.gov/ccl/regulatory-determination-1-support-documents-manganese>.

8. ADDITIONAL INFORMATION

Cross Connection Program

The District makes every effort that the water delivered to your home and business is clean, safe, and free of contamination. Our staff works diligently to protect the quality of the water delivered to our customers from the time the water is extracted via wells from underground aquifers throughout the entire treatment and distribution system. But what happens when the water reaches your home or business? There is still a need to protect the water quality from contamination caused by a cross-connection (Picture 5).

What is a cross-connection?

A cross-connection occurs whenever the drinking water supply is or could be in contact with potential sources of pollution or contamination. Cross-connections exist in piping arrangements or equipment that allow the drinking water to come in contact with non-potable liquids, solids, or gases (hazardous to humans) in event of a backflow. Figure 1 provides a basic concept of a cross connection.

Picture 4: District Performing a Backflow Test



Figure 1: Schematic of a Cross Connection

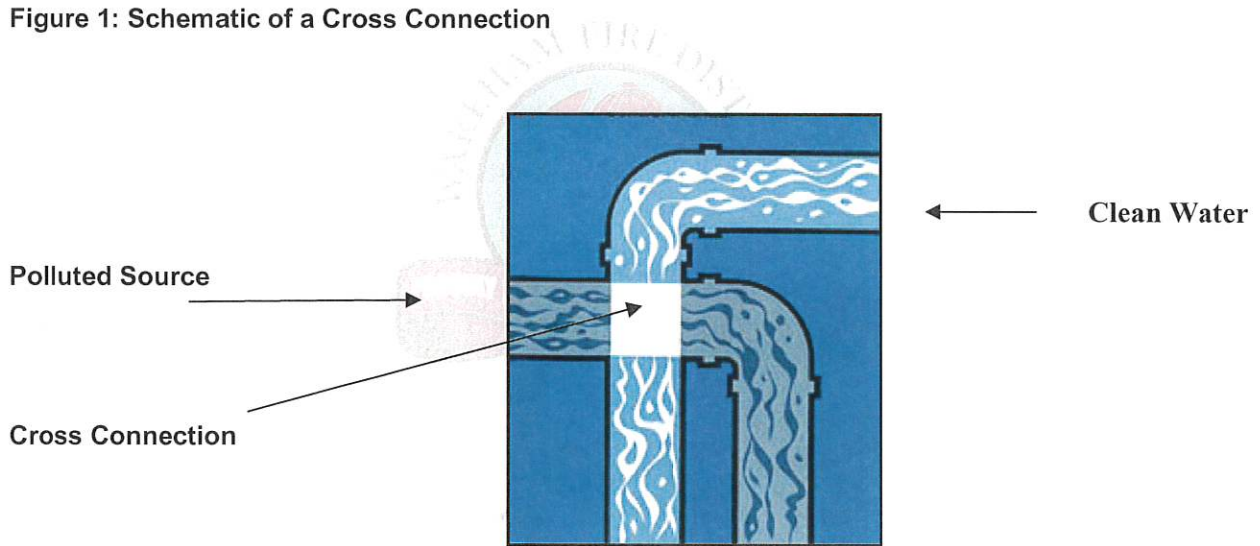

What is backflow?

Backflow is the undesired reverse of the water flow in the drinking water distribution lines. This backward flow of water can occur when the pressure created by equipment or a system, such as a boiler or air-conditioning, is higher than the water pressure inside the water distribution line (backpressure), or when the pressure in the distribution line drops due to routine occurrences such as water main breaks or heavy water demand causing the water to flow backward inside the water distribution system (back siphonage). Backflow is a problem that many water consumers are unaware can exist. And every water customer has a responsibility to help prevent them.

Figure 2: Back Pressure and Back Siphonage Concept

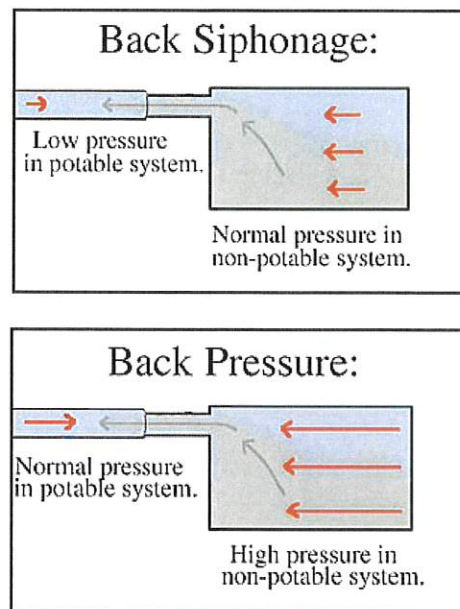

What you can do to help prevent a cross-connection

Without the proper protection, something as simple as a garden hose has the potential to contaminate or pollute the drinking water lines in your house. In fact, over half of the country's cross-connection incidents involve unprotected garden hoses. There are very simple steps that you, as a drinking water user, can take to prevent such hazards:

- **Never** submerge a hose in soapy water buckets, pet watering containers, pool, tubs, sinks, drains, or chemicals.
- **Never** attached a hose to a garden sprayer without the proper backflow preventer.
- **Do:** Buy and install a hose bib vacuum breaker on every threaded water fixture. The installation can be as easy as attaching a garden hose to a spigot. This inexpensive device is available at most hardware stores and home-improvement centers.
- **Do:** Identify and be aware of potential cross-connections to your water line.
- **Do:** Buy appliances and equipment with a backflow preventer.
- **Do:** Buy and install prevention devices or assemblies for all high and moderate hazard connections.

If you are the owner or manager of a property that is being used as a commercial, industrial, or institutional facility you must have your property's plumbing system surveyed for cross-connection. **If your property has NOT been surveyed for cross-connection, contact the District immediately to schedule a cross-connection survey.**

The Massachusetts Drinking Water Regulations, 310 CMR 22.00, requires all public water systems to have an approved and fully implemented Cross-Connection Control Program (CCCP). The District is working diligently to protect the public health of its drinking water customers from the hazards caused by unprotected cross-connections. We are doing this through the implementation of our cross-connection survey program, elimination or proper protection of all identified cross-connections, the registration of all cross-connections protected by reduced pressure backflow preventers (RPBPs) or double check valve assemblies (DCVAs), and the implementation of a testing program for all RPBPs and DCVAs. Figure 3 provides some typical examples of a cross connection.

Figure 3: Some Examples of Common Cross-connections

No Backflow Preventer (in this case for hose submerged in sink)

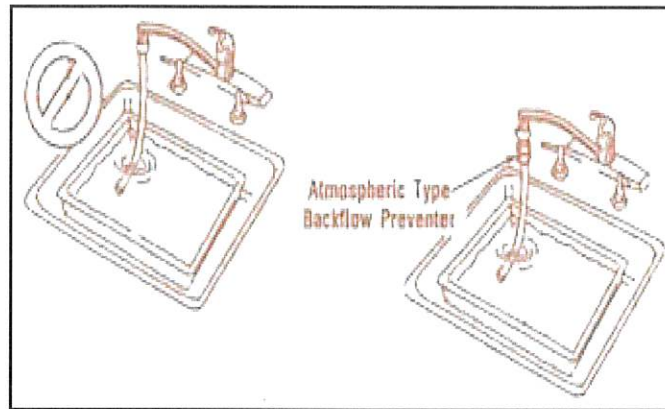

Potential Hose Submerged in Water Body (in this case tub)

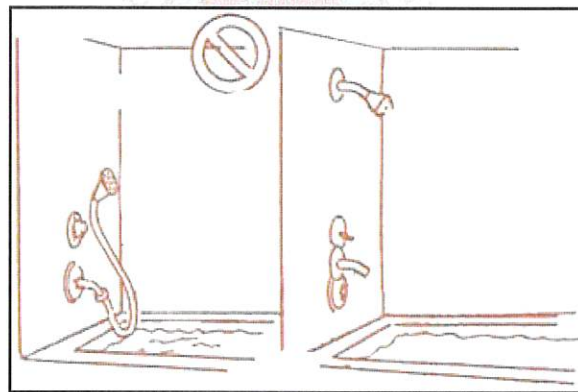

No Backflow Preventer (in this case for garden hose)

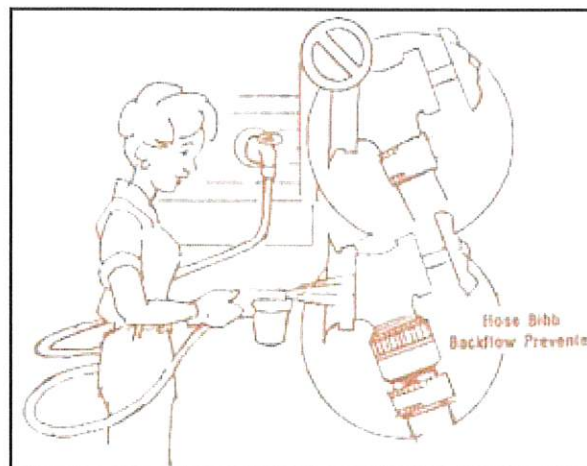
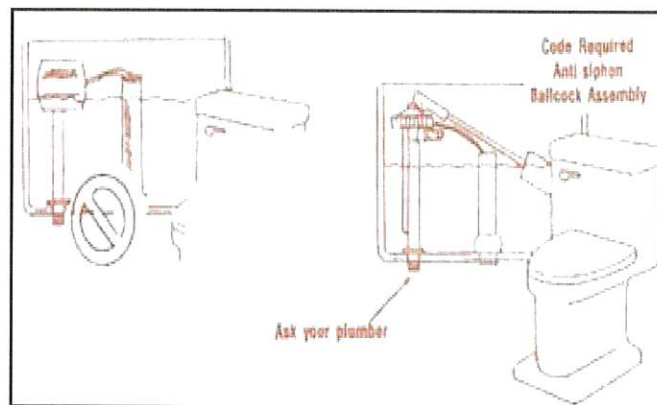
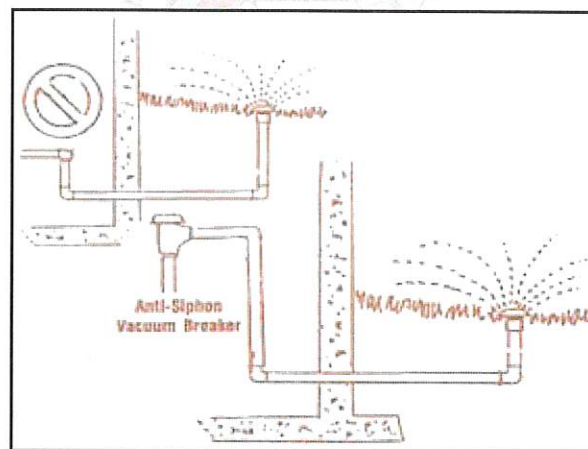

Figure 3 continued: Some Examples of Common Cross-connections

No Anti-Siphon for Toilet



No Anti-Siphon Device (in this case for sprinkler system)



{End of page. Go to Next Page}

Water Conservation

**ODD/EVEN LAWN SPRINKLER RESTRICTIONS IN EFFECT
MAY 1ST THROUGH SEPTEMBER 30TH - HELP CONSERVE!**

The Wareham Fire District Water Department consistently provides quality water to every tap. We ask you to help us protect and conserve our water sources. During the summer periods, the State as part of our Water Management Act Permit requires a lawn sprinkler restriction. Residents with odd number houses are allowed to water on odd days of the week (Monday, Wednesday, and Friday), and even number house on the odd days of the week (Tuesday, Thursday, Saturday). Sunday is the day of water rest. For our residential customers we offer **free** water conservation kits. There is a limit to one kit per address. To obtain one, please come by the Water Department office.

Figure 4: Water Saving Shower Head

